

# MATURO DYNAMOMETERS



Sales Partner:



Phone: +49 (0)9606 923913-0  
Fax: +49 (0)9606 923913-29

**ABSOLUTE EMC** LLC.  
Covering sales in North America  
United States, Mexico, & Canada

eMail: [info@matur-gmbh.de](mailto:info@matur-gmbh.de)  
Web: [www.matur-gmbh.de](http://www.matur-gmbh.de)

[absolute-emc.com](http://absolute-emc.com)  
Phone: 703-774-7505  
[info@absolute-emc.com](mailto:info@absolute-emc.com)

## 1. PRODUCT OUTLINE

All matur Dynamometers are designed for use in anechoic chambers for EMI and EMC measurements.

### Free-Standing Dynamometer (FR-DYN-F)

- Simple Installation
  - o On top of the turntable
  - o On the chamber floor
- Two passive axes for vehicles with rear, front or four-wheel drive
- Front and rear axis independent or mechanically coupled



### Free-Standing Dynamometer with four active roller pairs (F-DYN-4WD)

- Simple Installation
  - o On top of the turntable
  - o On the chamber floor
- Two active axes for vehicles with rear, front or four-wheel drive with or without limited slip differential
- Electrical coupling and synchronization of all rollers



### Dynamometer integrable into turntables (TT - DYN)

- Both versions are possible, active or passive axes
- Integrated into the turntable for completely flat chamber floor
- Three axes or more are possible

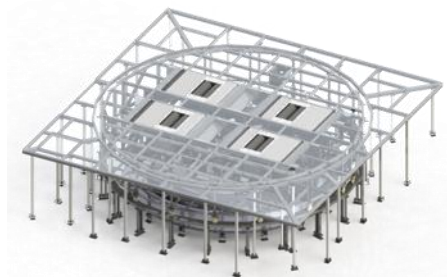

### Accessories

- In-house control Software and Controller FCU<sup>3.0</sup>
  - o Matur control App (mcApp) for controlling the Dynamometer
  - o Installation on an existing PC
- Cooling fan
  - o In front of the vehicle, as standalone or integrated in the turntable
  - o Controlled via mcApp or with power plug
  - o Integrated in the roller modules for the tire cooling
- Exhaust extraction system
- Driving robot system
  - o Driving the vehicle on the dynamometer
  - o Controlled via mcApp
  - o Pneumatic

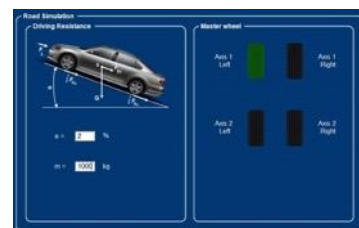

## 2. FREE STANDING DYNAMOMETER (FR-DYN-F)

The Dynamometer FR-DYN-F is constructed as a freestanding stand-alone dynamometer, which can optionally be fixed onto a turntable. Two passive axes are used for vehicles with rear/front or four-wheel drive. The four independent roller pairs are free-running and operated by the vehicle engine.

### EMC/EMI suitability

The FR-DYN-F is especially designed not to influence EMC and EMI measurements. Furthermore, it is tested based on CISPR 12/15, SAE J551-5, ECE R10, GBT18387.

### Preserving the surroundings

Due to minimize the dynamic energy to the surrounding of the FR-DYN-F. The four independent roller pairs are integrated into a "self-contained" frame.

### Example technical data, other specifications upon request

Axis distance	1400 mm – 3200 mm
Vehicle weight / axis load	3000 kg / 1500 kg
Dimensions in mm (L x W x H)	approx. 4000 x 2500 x 270
Total weight	approx. 2000 kg
Roller diameter	240 mm
Roller properties	Flame coated surface (road-like) static heaved up to 2000 rpm Balance quality: Q 2.5 according to VDI 2060
Track width	1000 mm to 2300 mm
Maximum speed	100 km/h
Temperature range	5° C – 45° C



### Accessories included:

- Two free adjustable ramps for loading and unloading the vehicle
- Lifting carriage system for simple movement
- Four lashing straps to fix the vehicle while running. They are integrated in the system structure and are adjustable to each specific vehicle and made of neutral material.  
Tensile strength: 5000 N  
Length adjustment: 1.0 m – 6.0 m
- Roller blocking system for easy loading or unloading of the vehicle
- Two emergency switches, one close to the dynamometer and one inside the control room.
- Triggering the switch sets all rollers to torque-free mode to prevent vehicle damage
- Safety cover for tires



### Accessories upon request:

- Speed sensor
- Increased permissible vehicle/axis weight
- Mechanical axis coupling to prevent triggering the vehicle's safety systems in the vehicle, e.g. ABS or ESP
- Clamping device for motorcycle
- Cooling system to keep the motor and/or the tires cool during testing



### 3. FREE STANDING DYNAMOMETER (F-DYN-4WD)

The Dynamometer F-DYN-4WD is constructed as a freestanding stand-alone dynamometer, which can optionally be fixed onto a turntable. Two active axes are used for vehicles with rear/front or four-wheel drive with or without limited slip differential. The four roller pairs are independently controllable, and each pair is driven by a separate motor, which also can work as a generator while the car is driven. The generated energy can be feedback to the power supply.

#### EMC/EMI suitability

The F-DYN-4WD is especially designed not to influence EMC and EMI measurements. Therefore, the electronic components are inside a shielded, radio interference suppressing box which is placed inboard the dynamometer.

<b>EMC Performances</b>	
<b>Emission</b>	
<b>10 dB under the limits of CISR 12 and CISR 25</b>	
Frequency range	150 kHz – 1 GHz
Measurement distance	10 m
<b>Emission, electrical</b>	
<b>6 dB under the limits of SAE J551-5: 2004-1, GB/T 18387-2008</b>	
Frequency range	9 kHz – 30 MHz
Measurement distance	3 m
<b>Emission, magnetic</b>	
<b>6 dB under the limits of SAE J551-5: 2004-1, GB/T 18387-2008</b>	
Frequency range	9 kHz – 30 MHz
Measurement distance	3 m
<b>Immunity</b>	
Continuous field strength	200 V/m
Frequency range	10 kHz – 18 GHz

#### Preserving the surroundings

Due to minimize the dynamic energy to the surrounding of the F-DYN-4WD, the four independent roller pairs are integrated into a “self-contained” frame.

#### ABS and ESP tests:

The dynamometer F-DYN-4WD allows ABS and ESP testing of vehicles up to an acceleration or deceleration of 1.0 g (10 m/s<sup>2</sup>).

Example technical data, other specifications upon request

Axis distance	1400 mm – 3200 mm
Vehicle weight / axis load	3000 kg / 1500 kg
Dimensions in mm (L x W x H)	approx. 4000 x 2500 x 400
Total weight	approx. 2500 kg
Roller diameter	240 mm
Roller properties	Flame coated surface (road-like) static heaved up to 2000 rpm Balance quality: Q 2.5 according to VDI 2060
Track width	1000 mm to 2300 mm
Maximum speed	120 km/h
Speed measurement accuracy	+/- 0.1 km/h
4 asynchronous servomotors/-generators	each 30 kW (total 60 kW per axis)
4 single axis inverters	Rectifier or rectifier/regeneration function
Voltage consumption	2x 380 V – 480 V / 3 phase
Current consumption	125 A
2 power supply devices	one per axis
Acceleration / deceleration	max. 1.0 g from 10 km/h to 60 km/h max 0.5 g from 60 km/h to 100 km/h

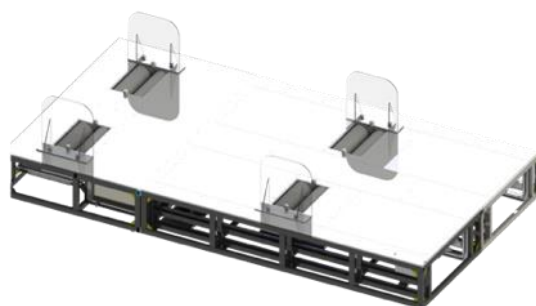
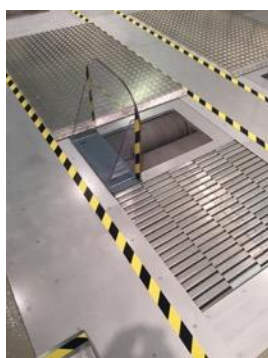

### Accessories included:

- Two free adjustable ramps for loading and unloading the vehicle
- Rollers for simple movement
- Four lashing straps to fix the vehicle while running. They are integrated in the system structure and are adjustable to each specific vehicle and made of neutral material.  
Tensile strength: 5000 N  
Length adjustment: 1.0 m – 6.0 m
- Roller blocking system for easy loading or unloading of the vehicle
- Two emergency switches, one close to the dynamometer and one inside the control room.
- Triggering the switch sets all rollers to torque-free mode to prevent vehicle damage
- Safety cover for tires



### Accessories on request:

- Speed sensor
- Increased permissible vehicle/axis weight
- Mechanical axis coupling for preventing a response of all driving safety systems in the vehicle, e.g. ABS or ESP
- Clamping device for motorcycle
- Increased motor power
- Increased maximum speed
- Movable axis for different axis distance, incl. Shutter system to ensure a continuous surface for movable axis



#### 4. DYNAMOMETER INTEGRABLE INTO TURNTABLES (TT - DYN)

The Dynamometer DYN-TT is constructed as a chassis dynamometer, which can be integrated into a turntable. Two active axes are used for vehicles with rear/front or four-wheel drive with or without limited slip differential. The four roller pairs are independently controllable, and each is driven by a separate motor/generator.

##### EMC/EMI suitability

The TT-DYN is especially designed not to influence EMC and EMI measurements. Therefore, the electronic components are inside a shielded, radio interference suppressing box which is placed inboard the dynamometer.

<b>EMC Performances</b>	
<b>Emission</b>	
More than 15 dB under the limits of CISR 12 and CISR 25	
Frequency range	30 MHz – 1 GHz
Measurement distance	10 m
<b>Emission, electrical</b>	
More than 10 dB under the limits of SAE J551-5: 2004-1, GB/T 18387-2008	
Frequency range	9 kHz – 30 MHz
Measurement distance	3 m
<b>Emission, magnetic</b>	
More than 10 dB under the limits of SAE J551-5: 2004-1, GB/T 18387-2008	
Frequency range	9 kHz – 30 MHz
Measurement distance	3 m
<b>Immunity</b>	
Continuous field strength	200 V/m
Frequency range	10 kHz – 18 GHz

All the design and manufacture of vehicle test bench is in accordance with standards below:

Ambient Noise requirements according to standards of CISR12, SAE J551-5

Vehicle velocity, acceleration, load, road simulation requirements and power grids requirements according to standards of CISR12, ISO11451, ECE R10, SAE J551, GB14023, GB18387, IEC61000-4-3, GB/T 14549.

##### Preserving the surroundings

Due to minimize the dynamic energy to the surrounding of the TT-DYN, the four independent roller pairs are integrated into a “self-contained” frame.

##### ABS and ESP tests:

The dynamometer TT-DYN allows ABS and ESP testing of vehicles up to an acceleration or deceleration of 1.0 g (10 m/s<sup>2</sup>).



Example technical data, other specifications upon request			
TYPE	DYN – 30 kW	DYN – 44 kW	DYN – 90 kW
Axis distance	1800 mm – 3200 mm		
Vehicle weight / axis load	4000 kg / 2000 kg		
Track width	1000 mm to 2300 mm		
Vehicle wheels diameter	min. 400 mm	min. 480 mm	min. 480 mm
Roller diameter	240 mm	320 mm	380 mm
Roller properties	Flame coated surface (road-like) static heaved up to 2000 rpm Balance quality: Q 2.5 according to VDI 2060		
Maximum speed	120 km/h	150 km/h	200 km/h
Speed measurement accuracy	+/- 0.1 km/h		
Acceleration / deceleration	max. 1.0 g from up to 50% max speed max 0.5 g from 50% max speed to max speed		
4 asynchrony servomotors/-generators	each 30 kW (total 60 kW per axis)	each 44 kW (total 88 kW per axis)	each 90 kW (total 180 kW per axis)
4 single axis inverters	Rectifier or rectifier/regeneration function		
Voltage consumption	2x 380 V – 480 V / 3 phase	2x 380 V – 480 V / 3 phase	2x 380 V – 480 V / 3 phase
Current consumption	125 A		250 A
2 power supply devices	one per axis		



### Accessories included:

- Four lashing straps to fix the vehicle while running. They are integrated in the system structure and are adjustable to each specific vehicle and made of neutral material.  
Tensile strength: 5000 N  
Length adjustment: 1.0 m – 6.0 m
- Roller blocking system for easy loading or unloading of the vehicle
- Two emergency switches, one close to the dynamometer and one inside the control room.
- Triggering the switch sets all rollers to torque-free mode to prevent vehicle damage
- Safety cover for tires

### Accessories on request:

- Speed sensor
- Increased permissible vehicle/axis weight
- Mechanical axis coupling for preventing a response of all driving safety systems in the vehicle, e.g. ABS or ESP
- Clamping device for motorcycle
- Increased motor power
- Increased maximum speed
- Movable axis for various axis distances, incl. Shutter system to ensure a continuous flat surface for movable axis
- More than two active axes, e.g. a third movable axis

**Please note: If the axis distance or the axis number increases, the minimum turntable size is also increased!**

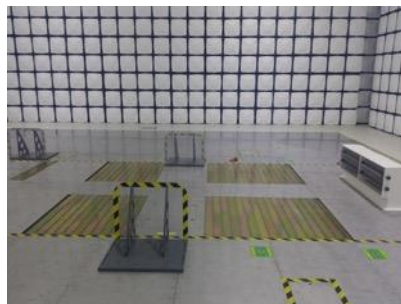
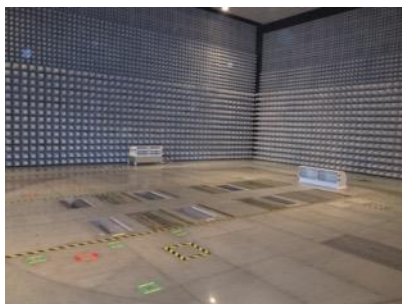

## 5. Features and accessories of the dynamometers

There are many features, benefits and accessories included in the standard delivery scope of maturo dynamometers.

Furthermore, extra accessories are provided in order to ensure a safe, efficient and easier work for our customers.

The following items are a small outline of the included or requestable equipment for the maturo dynamometers.

### Asynchronous – Servomotors from Bosch – Rexroth

- short delivery time to our company and to sites all over the world
- high reliability
- high dynamic
- possibility of energy recuperation
- whole dynamometer supplied by only one power cable

### Twin rollers

- compact design of complete system
- quick test setup
- simple vehicle fixing



### Tire cooling (optional)

- Extra cooling fans can be installed below the rollers in order to avoid tires being damaged by heat



### Tire safety cover

- Non-metal material
- Adjustable for different wheel tracks



### Fixing points incl. lashing straps

- to fix the vehicle during tests
- lashing straps made of non-metal material
- shieldable fixing points integrated in the turntable cover plates

### Stand-alone or turntable integrated cooling fan system (optional)

- adjustable guide plates for wind direction
- different maximum air flows and maximum wind speeds available, e.g. (20 000 m<sup>3</sup>/h and 80 km/h)
- wind speed optionally adjustable or automatically adjusted depending on vehicle speed
- The stand-alone option is equipped with four wheels for easy movement and made of plastic and wood.
- The integrated option is also removable (resulting hole can be covered by the incl. stainless steel plates) and the materials above the turntables are plastics.

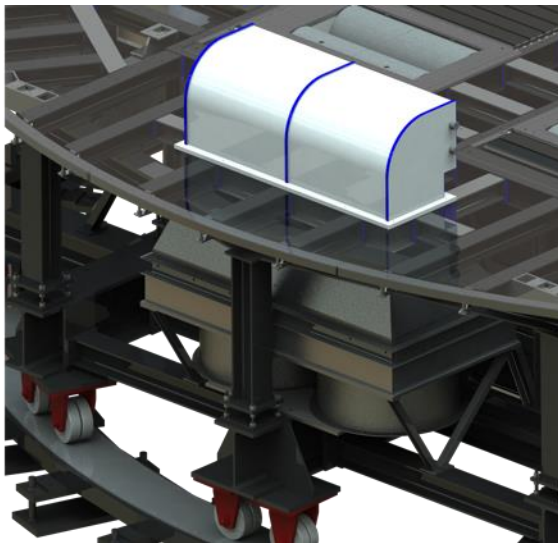

### Exhaust system up to 400° C (optional)

- Movable soft exhaust pipe (up to 5 m) on turntable made of non-metallic material
- Integrated exhaust channels in turntable, each equipped with cover
- Fixed exhaust line underneath the cover, provided up to the honeycomb in the shielding wall

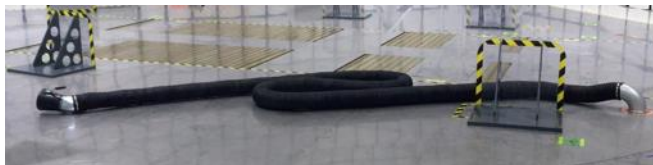

### Robot R – AB for accelerator and brake pedal (optional)

- Remote controlled vehicle driving on chassis dynamometer for EMC tests
- Actuation of pedal positions to external, analogue setpoints
- Safe non-energized basic positions
- Quick snap-in mechanism of pedal actuator for individual settings
- Easy mounting in vehicle
- No EMC emission due to pneumatic operation

Technical data	
Stroke distance accelerator stepless adjustable	up to 100 mm
Strength	200 N
Stroke distance brake stepless adjustable	up to 125 mm
Strength	350 N
Power consumption	208 VAC – 230 VAC, 50Hz / 60 Hz, single phase
Current consumption	approx. 0.5 A
Fuse	2 A, 250 V
Compressed air supply	via pressure regulator and 0.5 inch quick connector
Signal pressure	0.2 – 1.0 bar
Nominal pressure	5 bar
Length of lines	Air tube 5 m from dynamometer to robot
Operating temperature	5° C – 40° C
Total weight	approx. 25 kg



### Power supply for DUT/EUT (optional)

- DUT/EUT power supply distribution via energy chain to the connection boxes (access panels) outside the turntable center
- Integration of various socket and connector types for the DUT/EUT power supply, incl. charging points for electric vehicles up to 700 Amps



Energy chain principle:

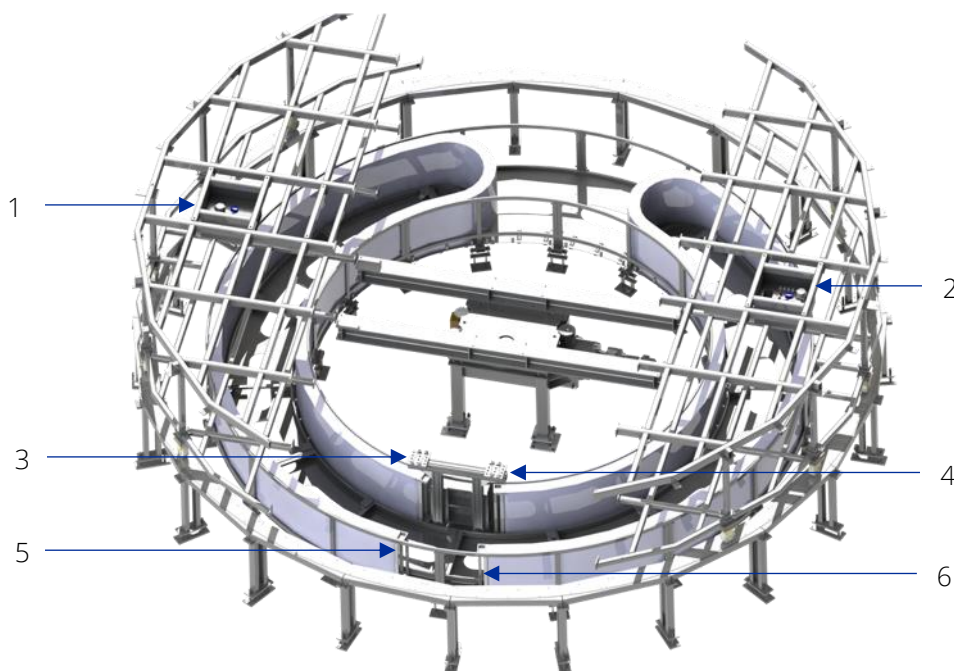

- 1 and 2 decentral access panels
- 3 and 4 rotating ends of the energy chains (mounted on the turntable)
- 5 and 6 fixed ends of the energy chains (mounted on the floor)

Power supply lines come from outside the chamber to the fixed positions (5 and 6). From there they are guided through the energy chain to the rotating ends (3 and 4). Due to the fact that the decentral access panels and the rotating energy chain ends are fixed to the rotating turntable, the distances are always constant between 1 and 3 and between 2 and 4. Therefore the power lines are connected from 3 to 1 and from 4 to 2 without any issues during rotation.

## 6. Software and Controller

The maturo controller FCU<sup>3.0</sup> and the maturo control App (mcApp) is developed by maturo engineers based on long experience. The in-house software mcApp is able to control all maturo devices including dynamometers and their accessories, e.g. the cooling fans, the robot and so on. It will be installed on a pre-existing PC (min. Windows 7) and communicate with the devices by fibre optics via the FCU<sup>3.0</sup>.

Furthermore, the mcApp can optionally read out the vehicle's bus, e.g. CAN-Bus.

Optionally, an industrial tablet is offered to control the maturo devices as a mobile, handheld compact solution.

Due to the fact that the controller and the software are exclusively produced, developed and constantly enhanced by maturo, software maintenance or troubleshooting in case of failing components can be done very fast, optionally with a remote service unit, for minimal downtimes.

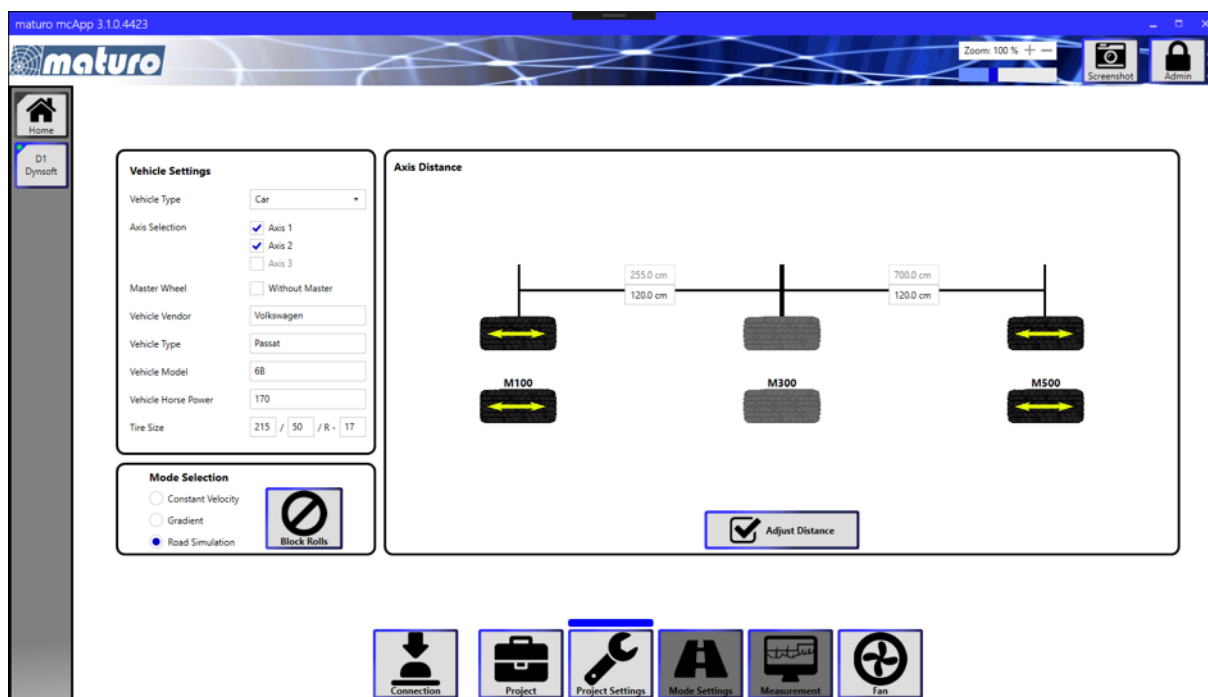

Operating modes:

- Recuperation mode: The dynamometer drives with constant speed and can load vehicle batteries. It is possible to set a certain acceleration, deceleration or speed.



- Gradient mode: Individual profiles, which can be set for each wheel independently

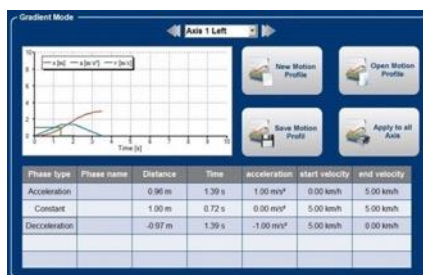
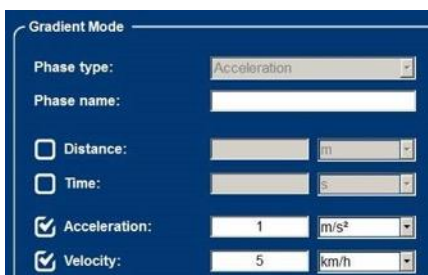

- Road simulation: The resistive torque can be adjusted with different parameters, like uphill/downhill angle, vehicle weight, or wind force factor.

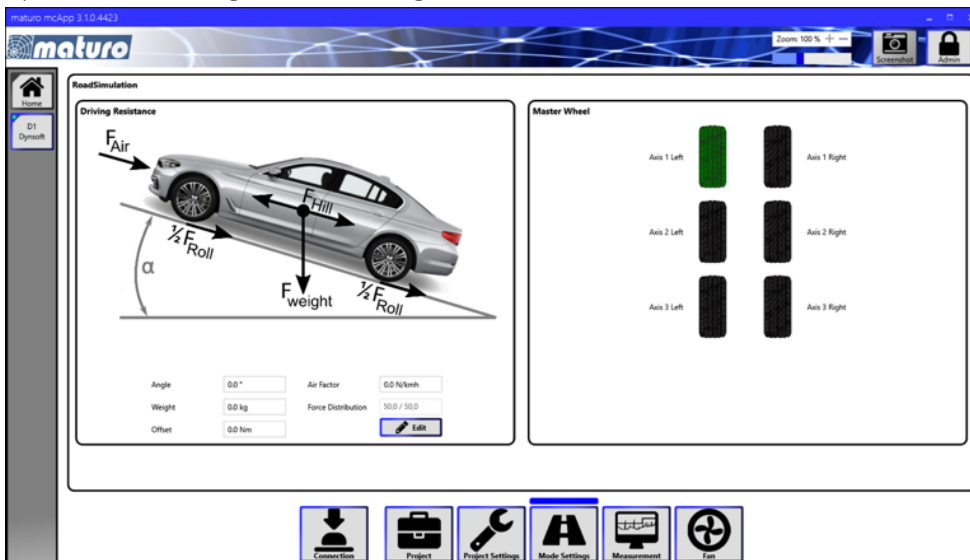



- Measurement: For each single wheel the following parameters can be measured and visualized in a graph:
  - Current torque of the motor in Nm
  - Current speed of the wheel in km/h
  - Current power of the motor in W
  - Current rotations of the vehicle wheel in rpm

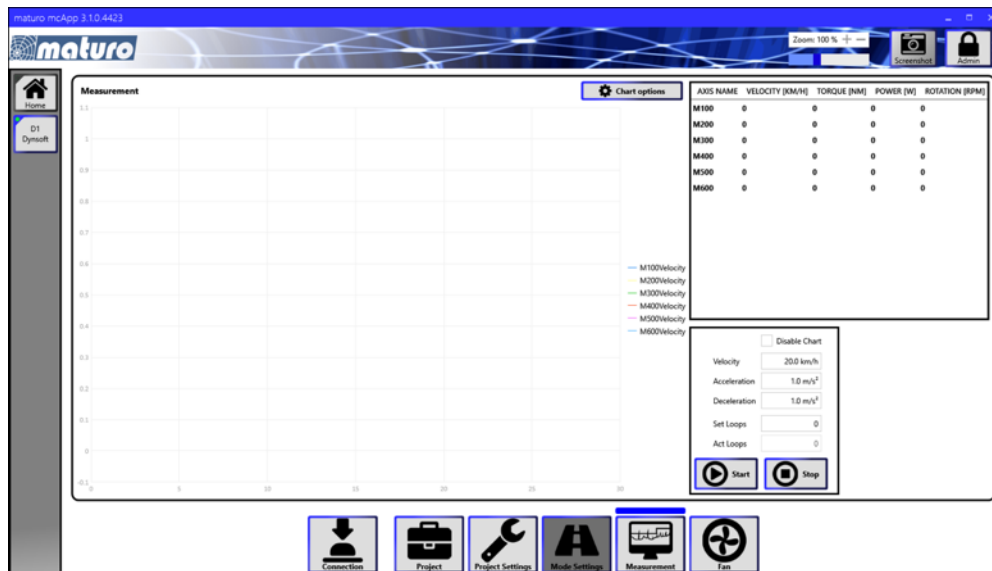

- Roll blocking mode for easy setup of the vehicle
- ESP/ABS mode (optional): Different torque on rollers for testing the ESP and ABS function

## 7. Highlights and advantages

- The software, namely mcApp, is developed completely by matur engineers
- Due to the in-house software very short response time in case of service
- Axis distance automatically adjustable over mcApp
- Full functionality of the Handheld control unit
  - Stay in the chamber and control all functions of the dynamometer, such as the axe distance, roller speed and so on
- Twin roller system for short setup-time, tire-sparing design and due to lower moment of inertia quick reaction to velocity changes
- Maintenance-free energy chain
- Exclusively well-known suppliers with subsidiaries all over the world
  - Short delivery times for spare parts

Sales Partner:



**ABSOLUTE EMC** LLC.  
Covering sales in North America  
United States, Mexico, & Canada

absolute-emc.com  
Phone: 703-774-7505  
info@absolute-emc.com

Phone: +49 (0)9606 923913-0  
Fax: +49 (0)9606 923913-29

eMail: info@matur-gmbh.de  
Web: www.matur-gmbh.de